

Rozdiely v schematickom editore Eagle 5 a Eagle 6

Ing. Katarína Sekáčová

Rozdiely

Eagle 5



príkaz **Cut**

Eagle 6

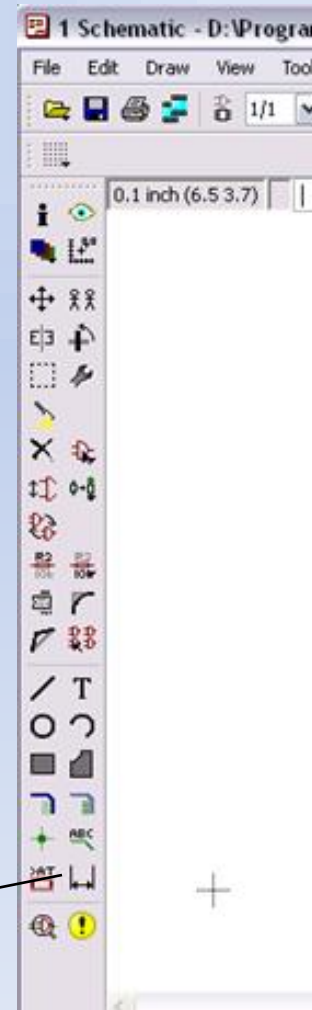

príkaz **Dimension**

Rozdiely

Eagle 5



príkaz **Description** –
popis

príkaz **Schematic
description** –
popis schémy

príkaz **Assembly
variants** –
súhrn variantov

Eagle 6

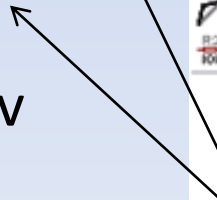
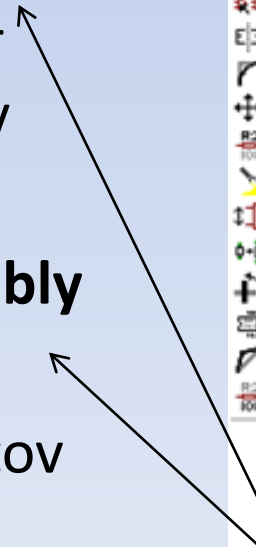
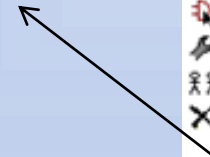

Rozdiely

Eagle 5

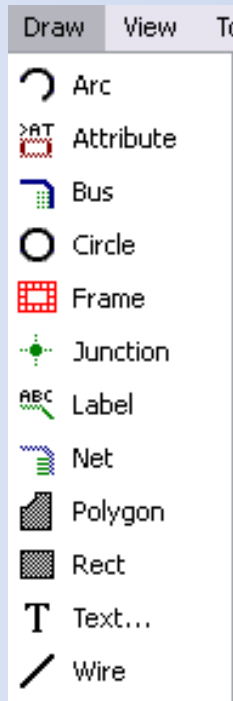

príkaz **Dimension** –
rozmer

Eagle 6

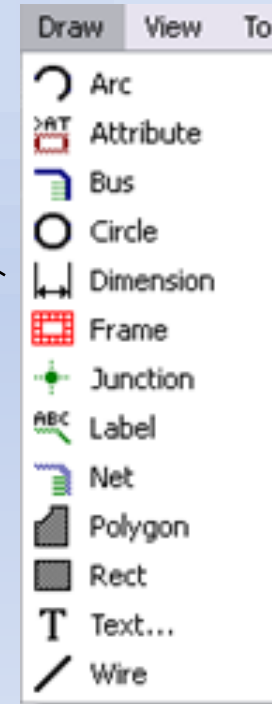

Eagle 6.5

Príkaz **Open Symbol** – editácia schematickej značky

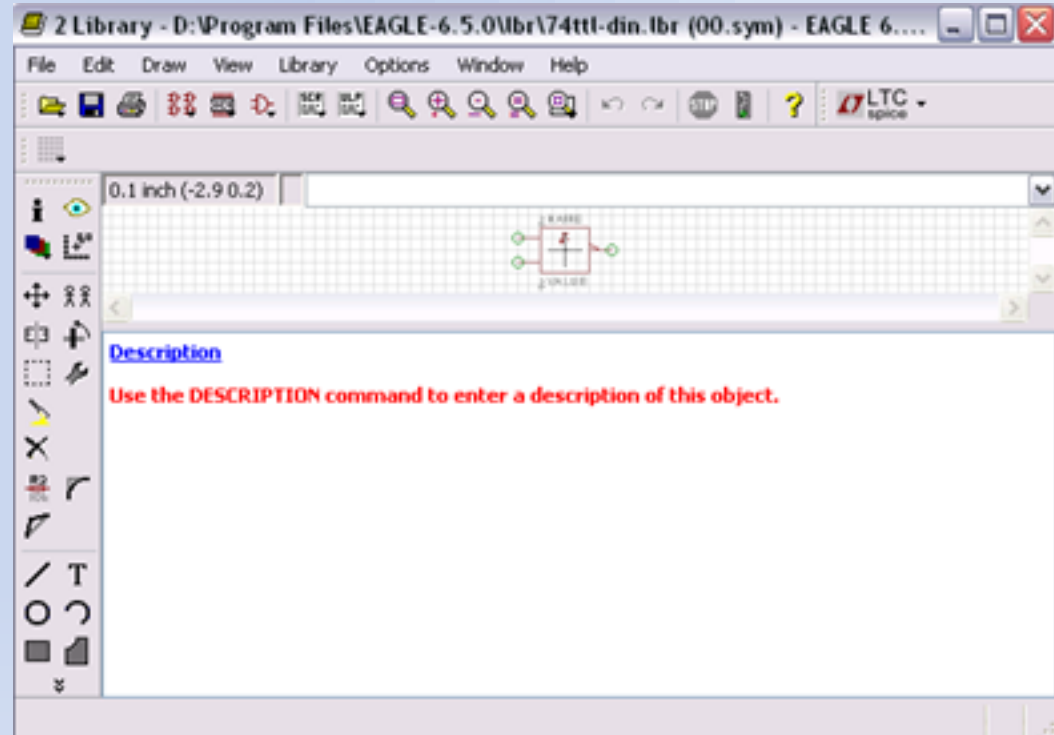
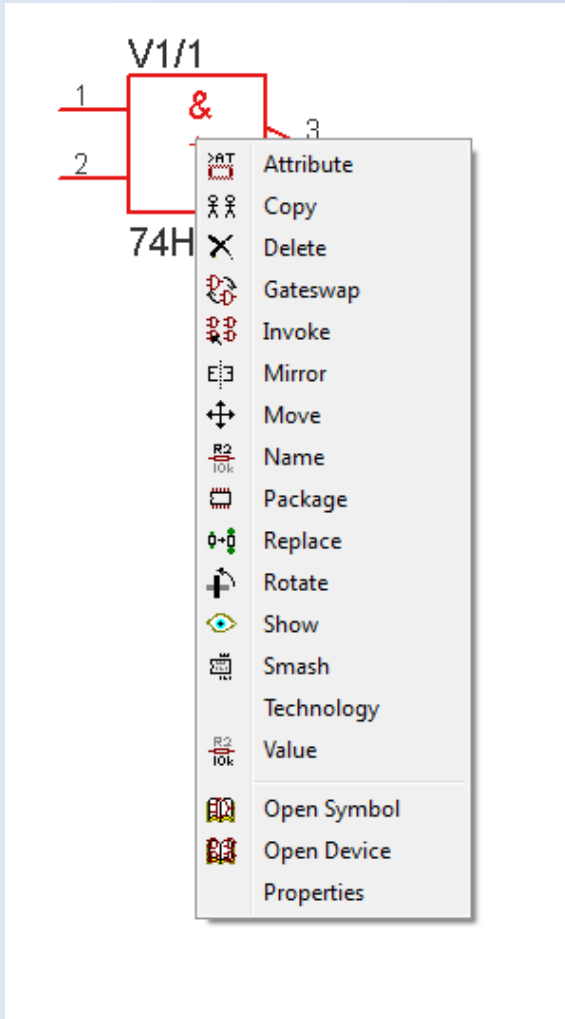

Edit – description – popis symbolu – OK

Eagle 6.5

úprava symbolu

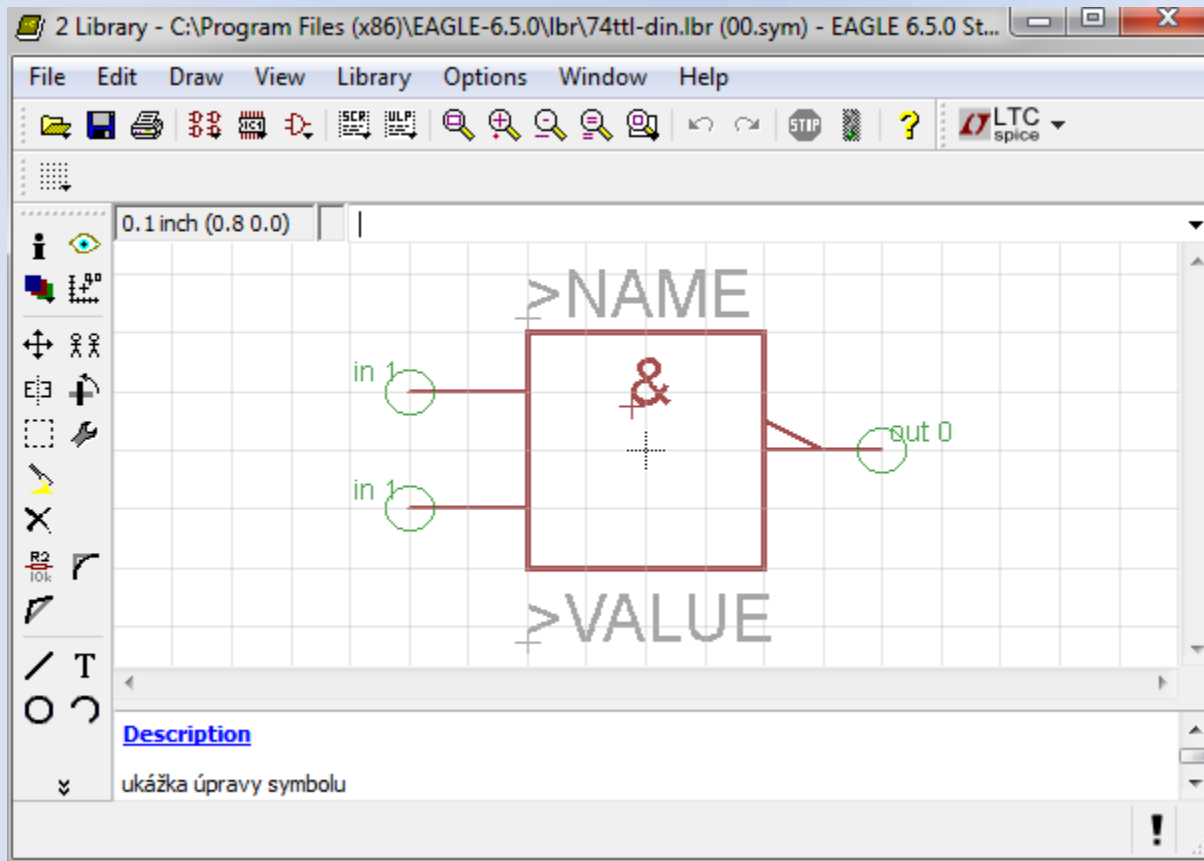

Eagle 6.5

úprava symbolu

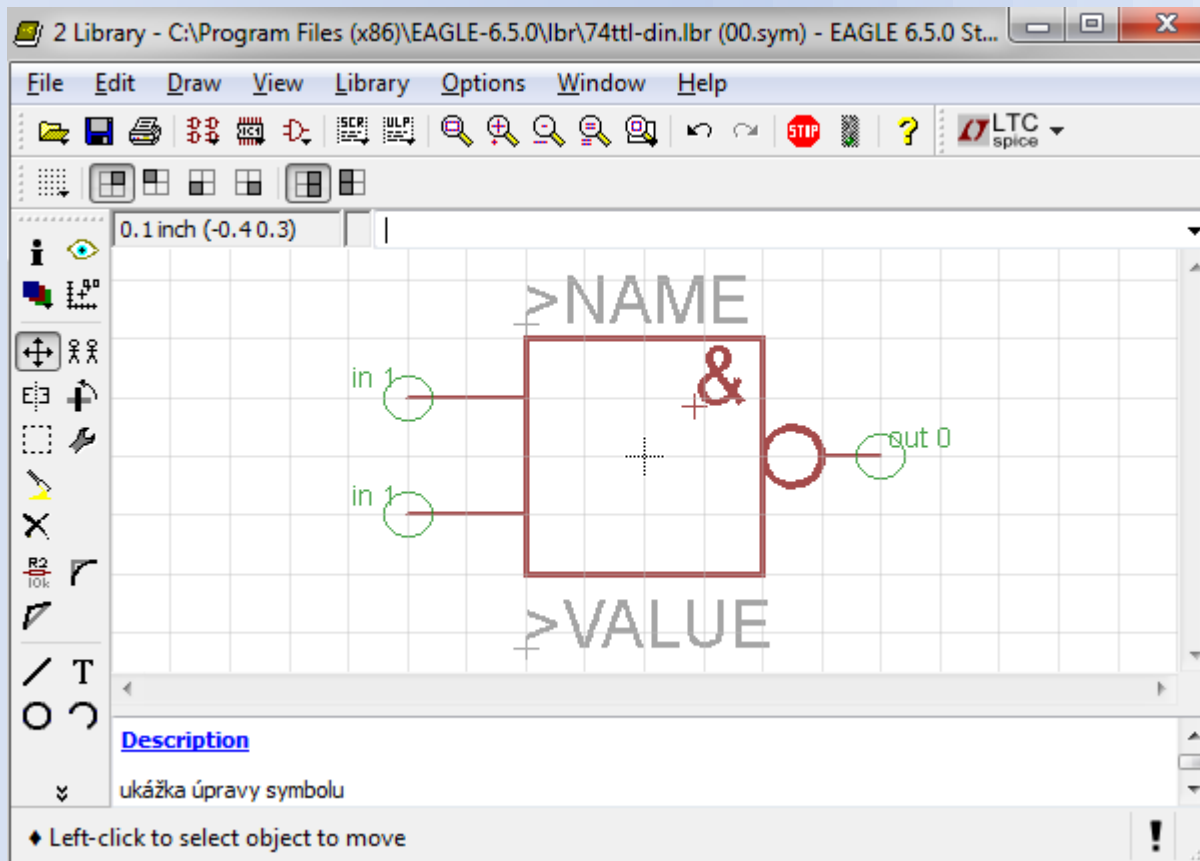

Eagle 6.5

Príkaz Dimension

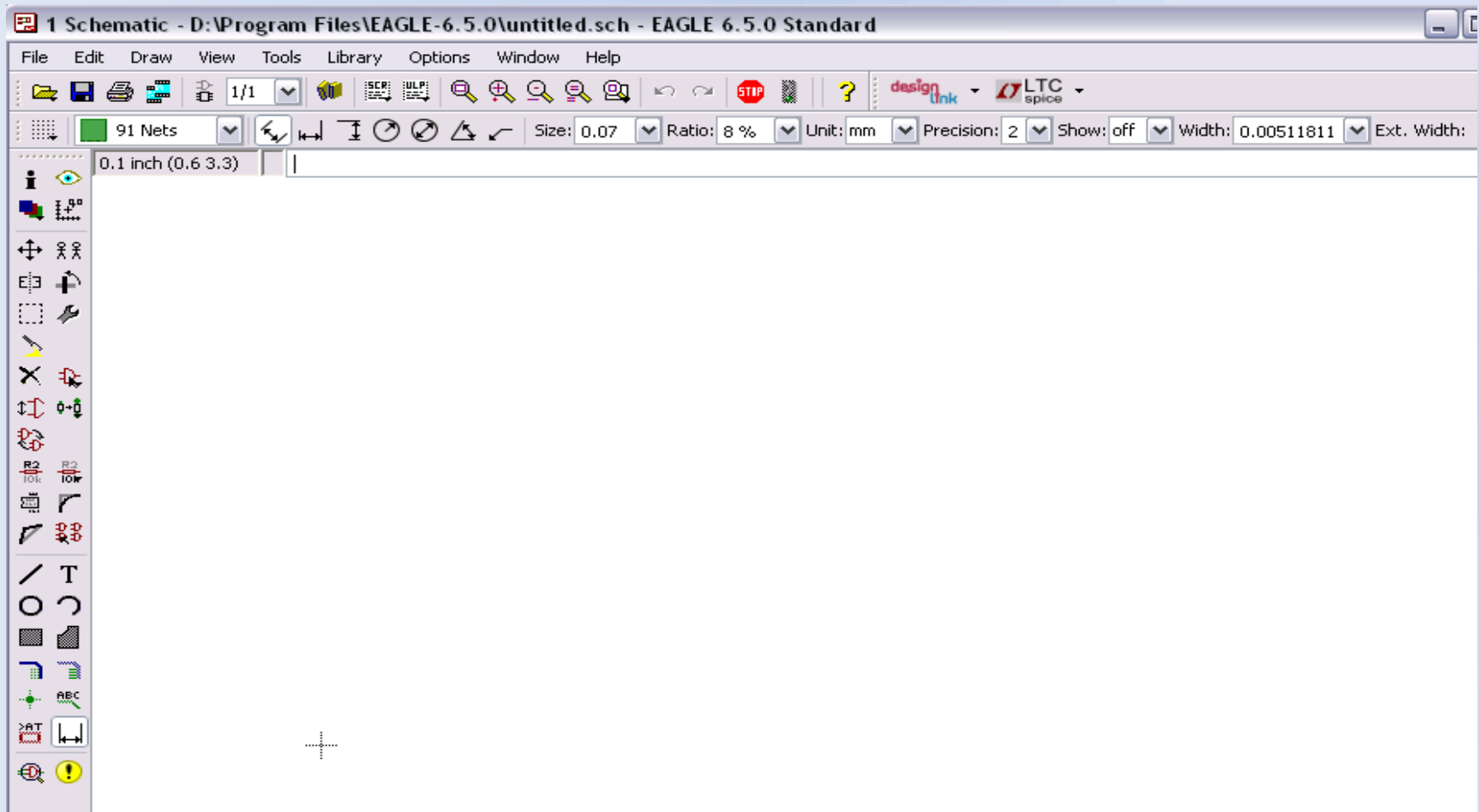

Eagle 6.5

Príkaz **Dimension**:

Pred použitím nastaviť mriežku na rovnakú hodnotu ako pri zobrazovaní rozmeru

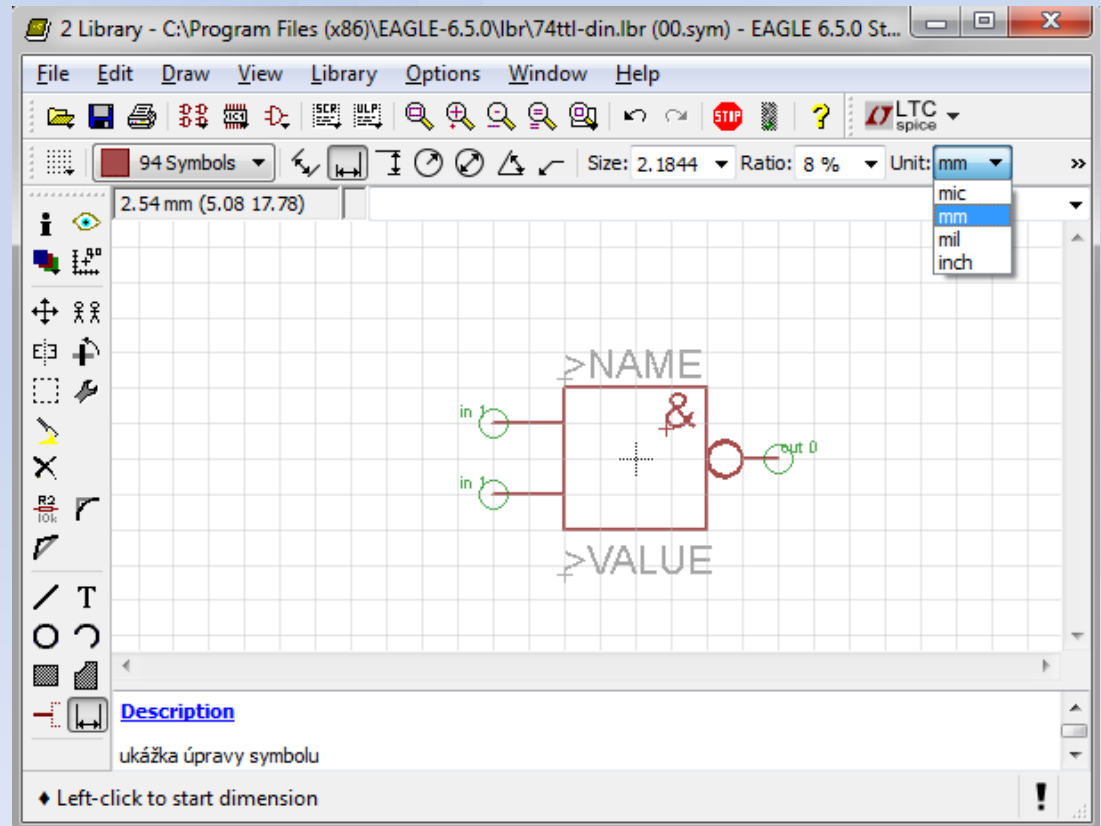
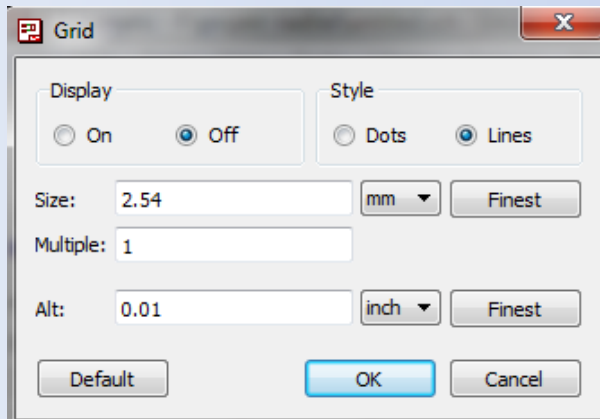

Eagle 6.5

Príkaz Dimension

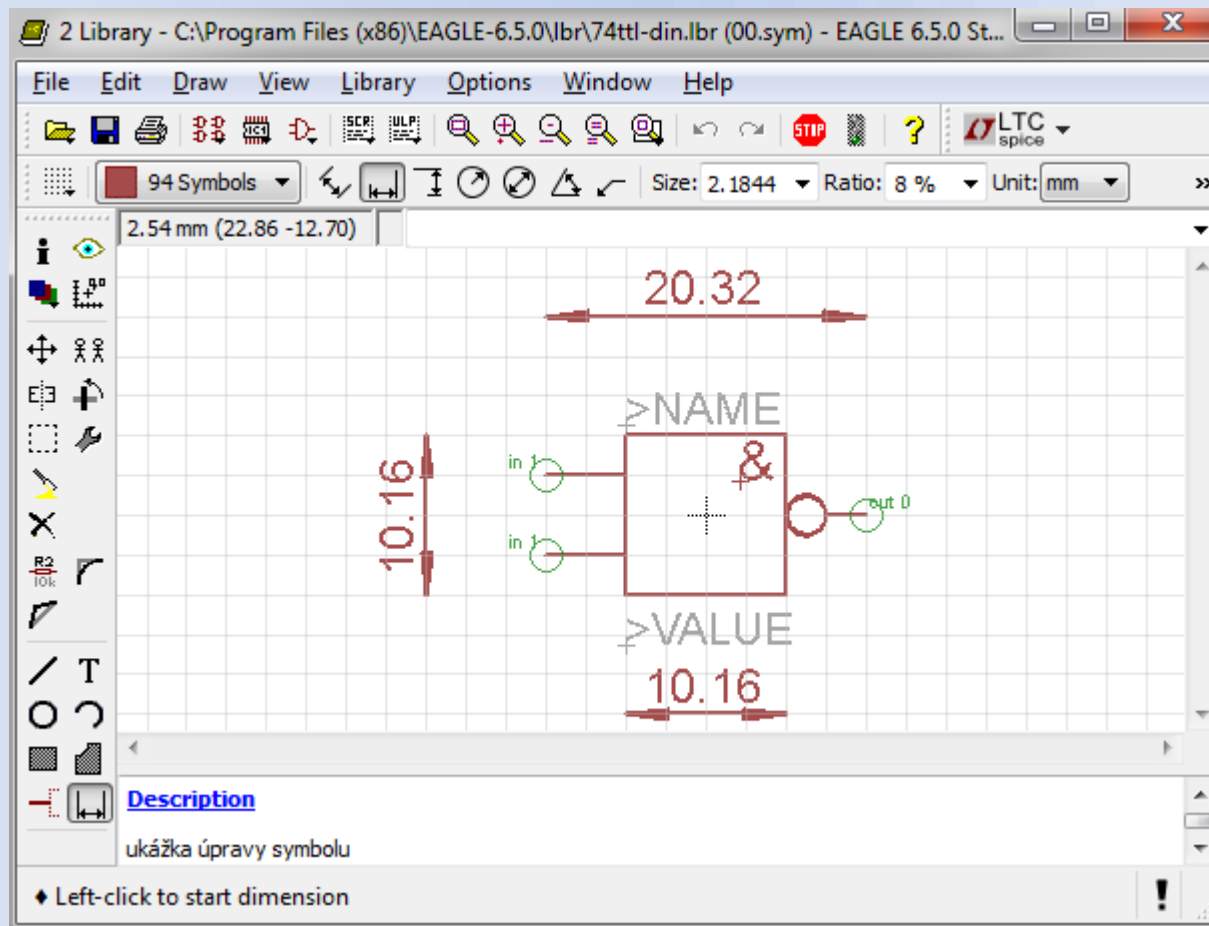

Eagle 6.5

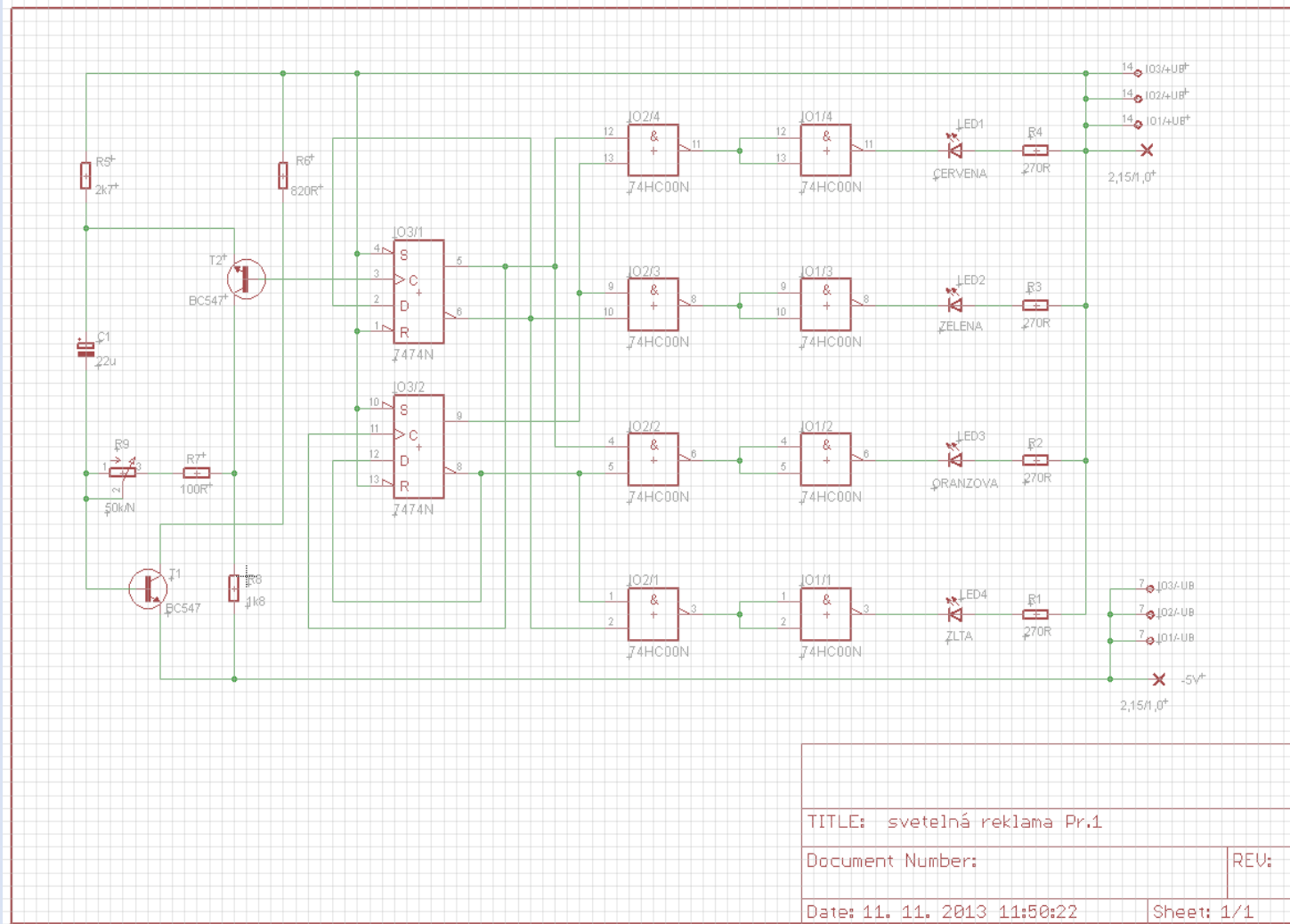

Eagle 6.5

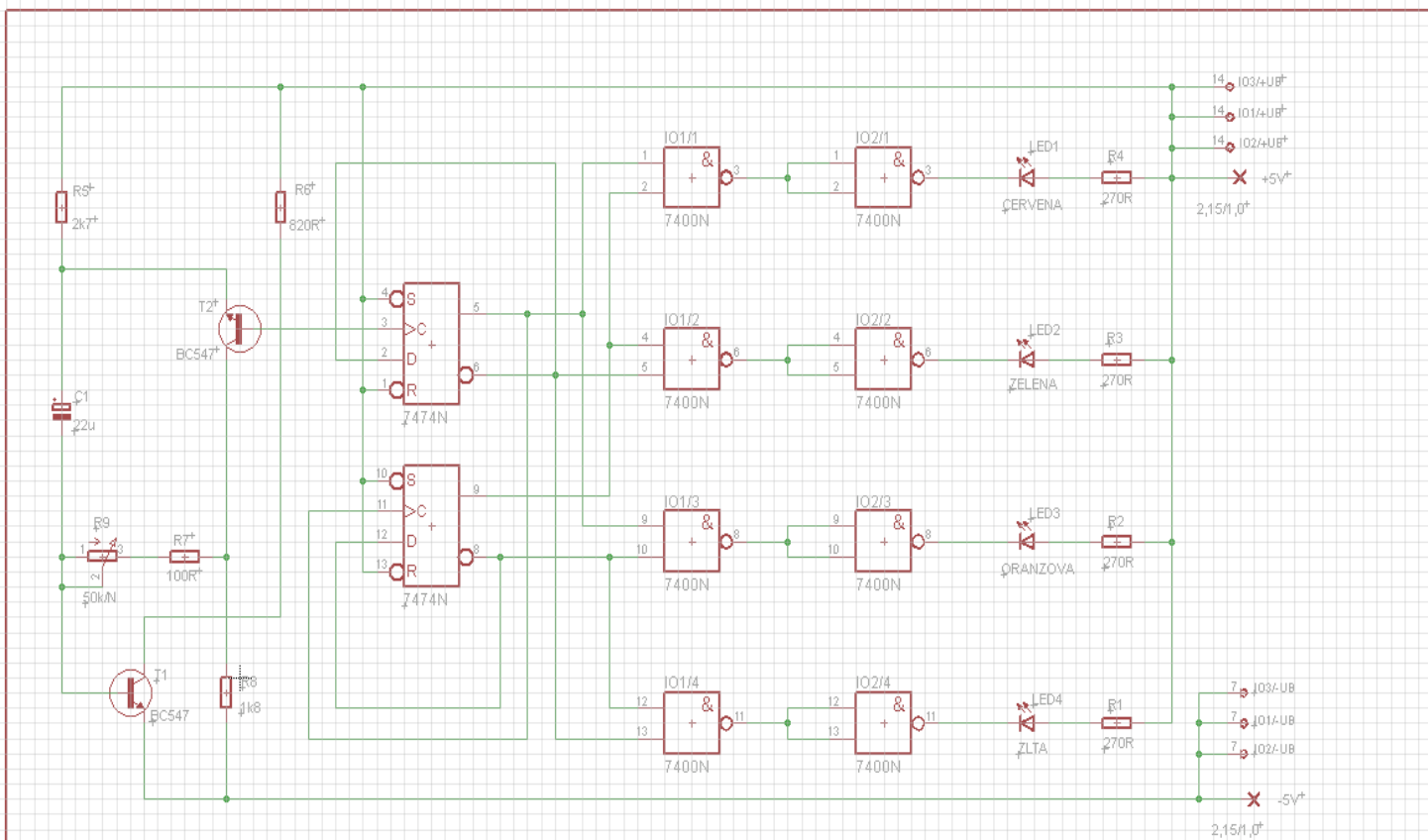

TITLE: svetelná reklama upravené IO Pr.1

Document Number:

REV:

Date: 11. 11. 2013 11:55:56

Sheet: 1/1

Ďakujem za pozornosť

Ing. Katarína Sekáčová